

■ BM-16 | BEVELLING MACHINE

Portable, handy beveling machine is designed for milling edges of plates and pipes made of steel, aluminum alloys, brass, or plastic.

Depending on the chosen milling head the machine enables beveling materials with minimum thickness of 1.5 mm (0.06") at the angles of 22.5°, 30°, 37.5°, 45°, 55° or 60° and with maximum bevel width of 16 mm (0.63").

Each milling head uses 5 indexable cutting inserts.

One milling head for beveling radius enables beveling edges with radius of 2, 3, 4 or 5mm with use of 4-sided indexable R2, R3, R4 or R5 cutting inserts.

Countersinking of holes with minimum 40 mm (1.57") diameter is also possible.

BM-16 is equipped with continuous bevel width adjustment, overload protection and electronic speed control for use on a variety of materials.

It is highly efficient machine for edge weld preparation and rounding off steel construction before painting or coating.



Max bevel width
16 mm



Bevel radius
R2, R3, R4 or R5



Pipe OD beveling



Top beveling



Arched edge
beveling



Pipe ID beveling
Min. ID 40 mm



Bevel angles
22.5°, 30°, 37.5°,
45°, 55° or 60°



Countersinking
Min. ID 40 mm

BM-16 TECHNICAL SPECIFICATION

Power supply	1~ 110-120 V, 50-60 Hz 1~ 220-240 V, 50-60 Hz
Motor	2200 W
Spindle speed (without load)	1800–5850 rpm
Maximum bevel width	b=16 mm (0.63", Fig. 2)
Bevel angle (depending on milling head)	$\beta = 22.5^\circ, 30^\circ, 37.5^\circ, 45^\circ, 55^\circ, 60^\circ$ (Fig. 2)
Minimal diameter of countersinking	ca 40 mm (1.57")
Rounding edges	R2, R3, R4, R5 (Fig. 1)
Dimensions (L x W x H)	585 mm (23.0") x 156 mm (6.1") x 238 mm (9.4")
Weight (without milling head)	10 kg (22 lbs)
Product code 220-240 V, 50-60 Hz	UKS-0509-10-20-00-0
Product code 110-120 V, 50-60 Hz	UKS-0509-10-10-00-0



Steel plate beveling



Arched edge beveling with radius

Basic set:

- BM-16 beveling machine without accessories (see list below)
- Metal box
- 32mm flat wrench
- Allen wrench hex s=5
- Allen wrench hex s=14
- Operator's Manual (English)

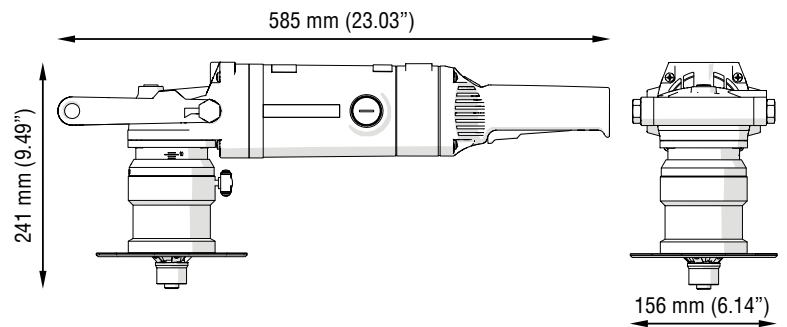

Accessories:

- GLW-000011 - Milling head for rounding
- PLY-000360 - Cutting insert R2 (4pcs required)
- PLY-000159 - Cutting insert R3 (4pcs required)
- PLY-000160 - Cutting insert R4 (4pcs required)
- PLY-000161 - Cutting insert R5 (4pcs required)
- PLY-000391 - Cutting insert for steel (4 pcs required – bevel up to 7 mm)
- PLY-000423 - Cutting inserts for aluminum (4 pcs required – bevel up to 7 mm)

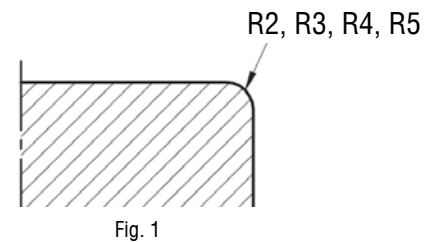
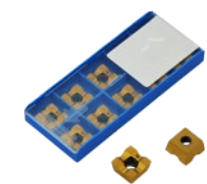
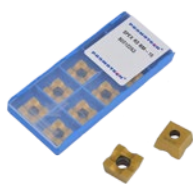

Fig. 1



Cutting insert R2



Cutting insert R3

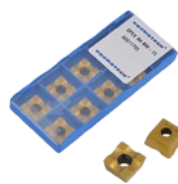

Cutting insert R4



Cutting insert R5

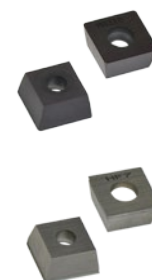

Cutting insert for steel

Cutting inserts for aluminum



Radius insert positioner for BM-16 and BM-7

Useful device for easy and precise setting of radius R2, R3, R4 and R5.

Product code: UST-0509-16-00-00-0

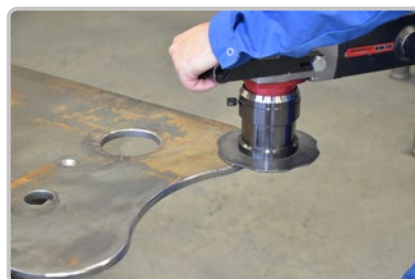
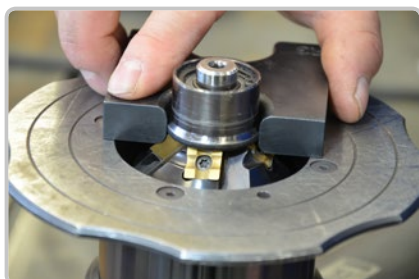

- GLW-000010 - Milling head 22.5°
- GLW-000005 - Milling head 30°
- GLW-000009 - Milling head 37.5°
- GLW-000006 - Milling head 45°
- GLW-000008 - Milling head 55°
- GLW-000007 - Milling head 60°
- PLY-000395 - Cutting insert for steel (5pcs required)
- PLY-000195 - Cutting insert for aluminum (5pcs required)

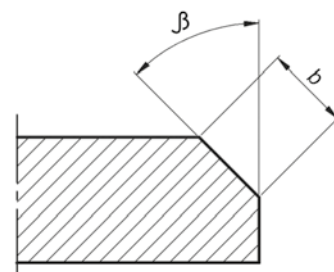

Milling head 22.5°



Milling head 30°



Milling head 37.5°

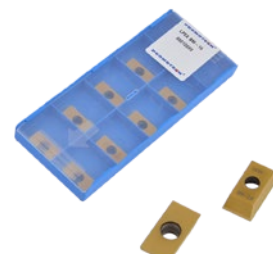

Cutting insert for steel



Milling head 45°

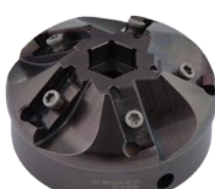

Milling head 55°



Milling head 60°



Cutting insert for aluminum

■ **Spare and consumable parts:**

- SRB-000289 - Insert Screw (Radius)
- SRB-000290 - Insert Screw
- RLK-0509-04-00-00-0 - Guiding roller
- SMR-000005 - Screw grease (5 g)
- SCZ-000030 - Motor brush for 230 V
- SCZ-000031 - Motor brush for 115 V
- NKL-0509-05-00-00-0 - Sticker against scratches (dedicated for aluminum beveling)



Insert Screw (Radius)



Insert Screw



Guiding roller



■ **Pipe attachment for BM-16**

Allows external beveling of pipes with a diameter of at least 150 mm (5.9") and internal beveling of pipes with a diameter of at least 110 mm (4.3").
Product code: PRW-0509-07-00-00-0

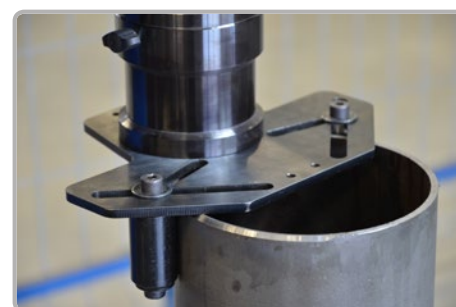



Worktable fixture for BM-16

Handy and convenient tool for machining small workpieces. with cross section of at least 15×25 mm (0.6×1”) and length of at least 400 mm (16”). The width of the workpiece can be up to 100 mm (4”), and height up to 65 mm (2.5”). The maximum bevel width is 14 mm (0.55”).

Product Code: ZBD-0509-12-00-00-0

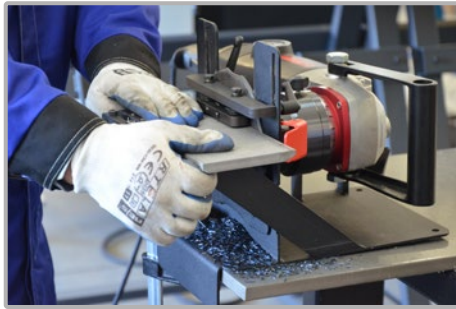
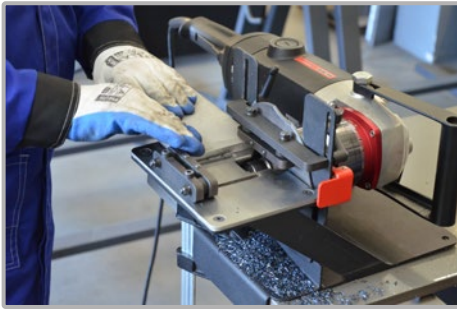

HD-CUT eco-friendly cooling/lubricating products

Non-corrosive with excellent rust protection, biodegradable coolants offer superior cooling properties and produce outstanding tool life and cut finish.

HD-CUT OIL 1 - tapping, drilling and machining fluid

product codes:

OLJ-0505-09-00-00-0 (0.5 kg)

OLJ-0505-10-00-00-0 (1.0 kg)

OLJ-0505-11-00-00-0 (5.0 kg)



HD-CUT BIO - concentrated micro emulsion for various machining applications

product code:

CHL-0440-42-00-00-0



HD-CLEAN SPRAY multi-purpose industrial degreaser

product code:

ZMY-0440-40-00-00-0



HD-CUT Spray - tapping, drilling and machining multi-position spray

product code:

PRE-0440-41-00-00-0



Aluminum beveling

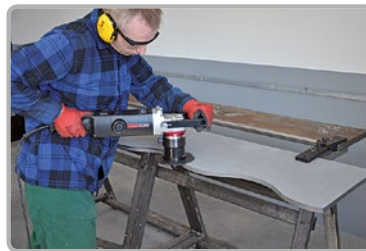

Curved edge beveling



Pipe beveling



Countersinking



PROMOTECH Sp. z o.o.
ul. Elewatorska 23/1, 15-620 BIAŁYSTOK, POLAND
tel. (+48 85) 678 34 05, fax (+48 85) 662 78 77
marketing@promotech.eu www.promotech.eu

Your local dealer:

