

8AFL 270 kg - standard model

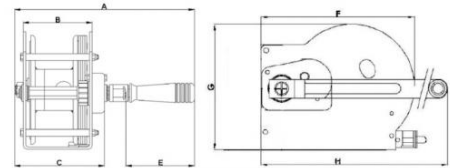

Hand self-braked spurgear winch 270 kg, standard model (zinc protection).

Use:

- Lifting or pulling/hauling operations
- Occasional use or leisure
- Small lifting height
- Hanging chandeliers
- Light trailer (quad, lawn tractor...)

Comply with Machines Directive 2006/42/EC. Developed and manufactured in accordance with standard NF E N 13157.

Technical properties

- Compact winch.
- Small size.
- Robust: chassis and steel drum.
- Automatic brake.
- Easy to install (2 or 3 points of fixation depending on models).
- To use with steel ropes.
- Stainless steel model available.

Technical characteristics of 8AFL 270 kg - standard model

Capacity 1st layer kg	650
Capacity top layer kg	270
Wire rope cap. top layer m	19
Wire rope Ø mm	6
Weight (without wire rope) kg	5.5

Dimensions

A mm	265
B mm	100
C mm	132
E mm	100
F mm	200
G mm	167
H mm	290

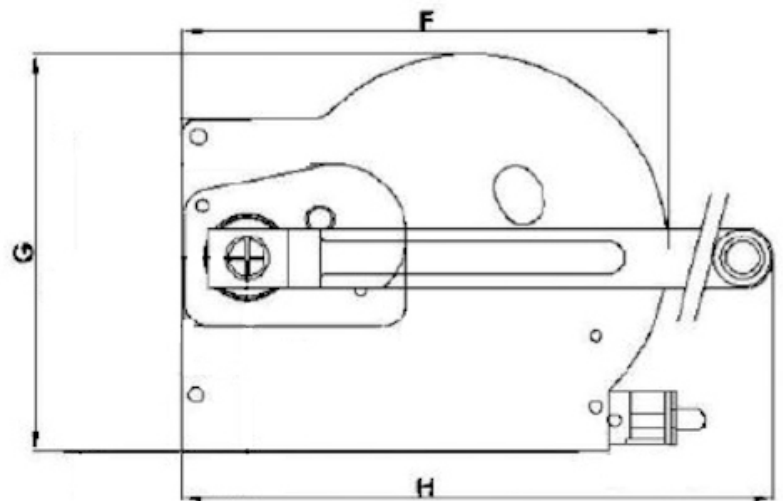
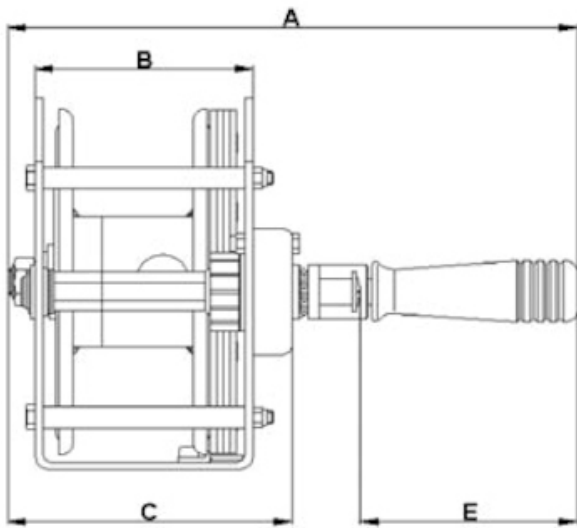

Technical characteristics of the other models of the range

References	4AFLM	4AFL	6AFL	8AFL	12AFL
Capacity 1st layer kg	190	340	500	650	900
Capacity top layer kg	80	190	240	270	490
Wire rope cap. top layer m	8	10	12	19	12
Wire rope Ø mm	3	4	5	6	7
Weight (without wire rope) kg	2.2	2.7	3.7	5.5	7.4

References	4AFLMINOX	4AFLINOX	6AFLX	8AFLX	12AFLINOX
Capacity 1st layer kg	190	340	500	650	900
Capacity top layer kg	80	190	240	270	490
Wire rope cap. top layer m	8	10	12	19	12
Wire rope Ø mm	3	4	5	6	7
Weight (without wire rope) kg	2.2	2.8	4.4	5.2	7.6



HUCHEZ's advice

Compact, easy to install and use.



HUCHEZ
 9, Grande Rue
 60420 FERRIERES – France
 ☎ +33 (0) 3 44 51 11 33
 Site internet : www.huchez.com
 E-mail : contact@huchez.fr



**SERVICE
 CLIENTS**

Pour en savoir plus, n'hésitez pas à nous contacter !
To know more, please contact us!